

Vigor C410/C510 Series VPN Router with WLAN/LTE/5G-NR Quick Start Guide

Version: 1.0

Firmware Version: V5.3.1

(For future update, please visit DrayTek web site)

Date: March 26, 2025

Intellectual Property Rights (IPR) Information

Copyrights	© All rights reserved. This publication contains information that is protected by copyright. No part may be reproduced, transmitted, transcribed, stored in a retrieval system, or translated into any language without written permission from the copyright holders.
Trademarks	The following trademarks are used in this document: <ul style="list-style-type: none">● Microsoft is a registered trademark of Microsoft Corp.● Windows 10, 11 and Explorer are trademarks of Microsoft Corp.● Apple and Mac OS are registered trademarks of Apple Inc.● Other products may be trademarks or registered trademarks of their respective manufacturers.

Safety Instructions and Approval

Safety Instructions	<ul style="list-style-type: none">● Read the installation guide thoroughly before you set up the router.● The router is a complicated electronic unit that may be repaired only by authorized and qualified personnel. Do not try to open or repair the router yourself.● Do not place the router in a damp or humid place, e.g. a bathroom.● Do not stack the routers.● The router should be used in a sheltered area, within a temperature range of 0 to +40 Celsius.● Do not expose the router to direct sunlight or other heat sources. The housing and electronic components may be damaged by direct sunlight or heat sources.● Do not deploy the cable for LAN connection outdoor to prevent electronic shock hazards.● Do not power off the device when saving configurations or firmware upgrades. It may damage the data in a flash. Please disconnect the Internet connection on the router before powering it off when a TR-069/ACS server manages the router.● Keep the package out of reach of children.● When you want to dispose of the router, please follow local regulations on conservation of the environment.
Warranty	We warrant to the original end user (purchaser) that the router will be free from any defects in workmanship or materials for a period of two (2) years from the date of purchase from the dealer. Please keep your purchase receipt in a safe place as it serves as proof of date of purchase. During the warranty period, and upon proof of purchase, should the product have indications of failure due to faulty workmanship and/or materials, we will, at our discretion, repair or replace the defective products or components, without charge for either parts or labor, to whatever extent we deem necessary to restore the product to proper operating condition. Any replacement will consist of a new or re-manufactured functionally equivalent product of equal value, and will be offered solely at our discretion. This warranty will not apply if the product is modified, misused, tampered with, damaged by an act of God, or subjected to abnormal working conditions. The warranty does not cover the bundled or licensed software of other vendors. Defects which do not significantly affect the usability of the product will not be covered by the warranty. We reserve the right to revise the manual and online documentation and to make changes from time to time in the contents hereof without obligation to notify any person of such revision or changes.



Declaration of Conformity

Hereby, DrayTek Corporation declares that the equipment type Vigor C410/C510 series is in compliance with Radio Equipment Directive 2014/53/EU, Low Voltage Directive 2014/35/EU and RoHS 2011/65/EU.

The full text of the EU Declaration of Conformity is available at the following internet address:

<https://fw.draytek.com.tw/Vigor%20C410/Document/CE/>

<https://fw.draytek.com.tw/Vigor%20C510/Document/CE/>

Manufacturer: DrayTek Corp.

Address: No.26, Fushing Rd., Hukou, Hsinchu Industrial Park, Hsinchu 303, Taiwan

Product: Vigor C410/C510 LTE/5G-NR Series

Frequency Information for Europe area:

2.4GHz WLAN	2400MHz - 2483MHz, max. TX power: 19.94dBm
5GHz WLAN	5150MHz - 5350MHz, max. TX power: 22.94dBm 5470MHz - 5725MHz, max. TX power: 29.88dBm
5G-NR	n1[1920-1980 MHz (TX); 2110-2170 MHz (RX)]; n3[1710-1785 MHz (TX); 1805-1880 MHz (RX)]; n7[2500-2570 MHz (TX); 2620-2690 MHz (RX)]; n8[880-915 MHz (TX); 925-960 MHz (RX)]; n20[832-862 MHz (TX); 791-821 MHz (RX)]; n28[703-748 MHz (TX); 758-803 MHz (RX)]; n38[2570-2620 MHz (TX/RX)]; n40[2300-2400 MHz (TX/RX)]; n77[3300-4200 MHz (TX/RX)]; n78[3300-3800 MHz (TX/RX)]
LTE	B1[1920-1980 MHz (TX); 2110-2170 MHz (RX)]; B3[1710-1785 MHz (TX); 1805-1880 MHz (RX)]; B7[2500-2570 MHz (TX); 2620-2690 MHz (RX)]; B8[880-915 MHz (TX); 925-960 MHz (RX)]; B20[832-862 MHz (TX); 791-821 MHz (RX)]; B28[703-748 MHz (TX); 758-803 MHz (RX)]; B38[2570-2620 MHz (TX); 2570-2620 MHz (RX)]; B40[2300-2400 MHz (TX); 2300-2400 MHz (RX)]
3G	B1[1920-1980 MHz (TX); 2110-2170 MHz (RX)]; B8[880-915 MHz (TX); 925-960 MHz (RX)]
	Requirements in AT/BE/BG/CZ/DK/EE/FR/DE/IS/IE/IT/EL/ES/ CY/LV/LI/LT/LU/HU/MT/NL/NO/PL/PT/RO/SI/SK/TR/FI/SE/CH/HR/UK(NI). 5150MHz-5350MHz is for indoor use only.

This product is designed for LTE, 5G-NR and 2.4GHz /5GHz WLAN network throughout the EC region.



Declaration of Conformity

Hereby, DrayTek Corporation declares that the equipment type Vigor C410/C510 series is in compliance with the Radio Equipment Regulations 2017 (SI 2017 No.1206, The Electrical Equipment (Safety) Regulations 2016 (SI 2016 No.1101), and The Restriction of the Use of Certain Hazardous Substances in Electrical and Electronic Equipment Regulations 2012 (SI 2012 No. 3032).

The full text of the UKCA Declaration of Conformity is available at the following internet address:

<https://fw.draytek.com.tw/Vigor%20C410/Document/CE/>

<https://fw.draytek.com.tw/Vigor%20C510/Document/CE/>

Manufacturer: DrayTek Corp.

Address: No. 26, Fushing Rd., Hukou, Hsinchu Industrial Park, Hsinchu 303, Taiwan

Product: Vigor C410/C510 LTE/5G-NR Series

Frequency Information for UK area:

2.4GHz WLAN	2400MHz - 2483MHz, max. TX power: 19.94dBm
5GHz WLAN	5150MHz - 5350MHz, max. TX power: 22.94dBm 5470MHz - 5725MHz, max. TX power: 29.88dBm
5G-NR	n1[1920-1980 MHz (TX); 2110-2170 MHz (RX)]; n3[1710-1785 MHz (TX); 1805-1880 MHz (RX)]; n7[2500-2570 MHz (TX); 2620-2690 MHz (RX)]; n8[880-915 MHz (TX); 925-960 MHz (RX)]; n20[832-862 MHz (TX); 791-821 MHz (RX)]; n28[703-748 MHz (TX); 758-803 MHz (RX)]; n38[2570-2620 MHz (TX/RX)]; n40[2300-2400 MHz (TX/RX)]; n77[3300-4200 MHz (TX/RX)]; n78[3300-3800 MHz (TX/RX)]
LTE	B1[1920-1980 MHz (TX); 2110-2170 MHz (RX)]; B3[1710-1785 MHz (TX); 1805-1880 MHz (RX)]; B7[2500-2570 MHz (TX); 2620-2690 MHz (RX)]; B8[880-915 MHz (TX); 925-960 MHz (RX)]; B20[832-862 MHz (TX); 791-821 MHz (RX)]; B28[703-748 MHz (TX); 758-803 MHz (RX)]; B38[2570-2620 MHz (TX); 2570-2620 MHz (RX)]; B40[2300-2400 MHz (TX); 2300-2400 MHz (RX)]
3G	B1[1920-1980 MHz (TX); 2110-2170 MHz (RX)]; B8[880-915 MHz (TX); 925-960 MHz (RX)]
	Requirements in UK. 5150MHz-5350MHz is for indoor use only.

This product is designed for LTE, 5G-NR and 2.4GHz /5GHz WLAN network use in the UK & Ireland.

Caution

Any changes or modifications not expressly approved by the grantee of this device could void the user's authority to operate the equipment.

The antenna/transmitter should be kept at least 20 cm away from human body.



External Power Supply ErP Information

*The external power supply used for each product will be model dependent.

	1	2	3	4	5	6	7	8	9	10	11	12
A Manufacturer	CWT	CWT	CWT	CWT	CWT	APD	APD	APD	APD	MOSO	MOSO	MOSO
B Address	No. 222, Sec. 2 Nankan Rd., Lujhu Township, Taoyuan County 338, Taiwan	No. 222, Sec. 2 Nankan Rd., Lujhu Township, Taoyuan County 338, Taiwan	No. 222, Sec. 2 Nankan Rd., Lujhu Township, Taoyuan County 338, Taiwan	No. 222, Sec. 2 Nankan Rd., Lujhu Township, Taoyuan County 338, Taiwan	No. 222, Sec. 2 Nankan Rd., Lujhu Township, Taoyuan County 338, Taiwan	No. 5, Lane 83, Lung-Sou St., Taoyuan City 330, Taiwan	No. 5, Lane 83, Lung-Sou St., Taoyuan City 330, Taiwan	No. 5, Lane 83, Lung-Sou St., Taoyuan City 330, Taiwan	No. 5, Lane 83, Lung-Sou St., Taoyuan City 330, Taiwan	Sangtai Industrial Park, Guanwai Xiaobaimang Songbai Road, Nanshan District, 518108 Shenzhen, Guangdong, China	Sangtai Industrial Park, Guanwai Xiaobaimang Songbai Road, Nanshan District, 518108 Shenzhen, Guangdong, China	Sangtai Industrial Park, Guanwai Xiaobaimang Songbai Road, Nanshan District, 518108 Shenzhen, Guangdong, China
C Model identifier	2ABB012F UK 2ABB012F EU	2ABB018F UK 2ABB018F EU	2ABL024F UK 2ABL024F EU	2ABL030F UK 2ABL030F EU	2ABN036F UK 2ABN036F EU	WA-12M12FG WA-12M12FK	WB-18D12FG WB-18D12FK	WA-24Q12FG WA-24Q12FK	WA-36A12FG WA-36A12FK	MS-V2000R120-024Q0-GB MS-V2000R120-024Q0-DE	MSS-V2500WR120-030E0-GB MSS-V2500WR120-030E0-DE	V30-V3000R120-036T0-GB V30-V3000R120-036T0-DE
D Input voltage	100-240V	100-240V	100-240V	100-240V	100-240V	100-240V	100-240V	100-240V	100-240V	100-240V	100-240V	100-240V
E Input AC frequency	50/60Hz	50/60Hz	50/60Hz	50/60Hz	50/60Hz	50/60Hz	50/60Hz	50/60Hz	50/60Hz	50/60Hz	50/60Hz	50/60Hz
Output voltage DC	12.0V	12.0V	12.0V	12.0V	12.0V	12.0V	12.0V	12.0V	12.0V	12.0V	12.0V	12.0V
F Output current	1.0A	1.5A	2.0A	2.5A	3.0A	1.0A	1.5A	2.0A	3.0A	2.0A	2.5A	3.0A
G Output power	12.0W	18.0W	24.0W	30.0W	36.0W	12.0W	18.0W	24.0W	36.0W	24.0W	30.0W	36.0W
H Average active efficiency	84.9%	86.2%	87.6%	87.8%	89.8%	83.7%	85.4%	88.6%	88.2%	87.8%	89.5%	89.3%
I Efficiency at low load 10%	73.6%	78.0%	81.3%	83.3%	83.7%	74.5%	80.5%	86.4%	85.4%	85.4%	84.7%	87.7%
J No-load power consumption	0.07W	0.07W	0.07W	0.07W	0.07W	0.07W	0.10W	0.07W	0.10W	0.10W	0.08W	0.10W

For more update, please visit www.draytek.com.

Table of Contents

1. Package Content	1
2. Panel Explanation.....	2
2.1 Vigor C410	2
2.2 Vigor C510	3
2.3 Vigor C410ax	4
2.4 Vigor C510ax	6
3. Hardware Installation	8
3.1 Network Connection	8
3.2 Wall-Mounted Installation.....	9
3.3 Antenna Installation.....	10
4. Software Configuration	12
5. Customer Service	14

1. Package Content

Take a look at the package content. If there is anything missed or damaged, please contact DrayTek or dealer immediately.



Vigor Router

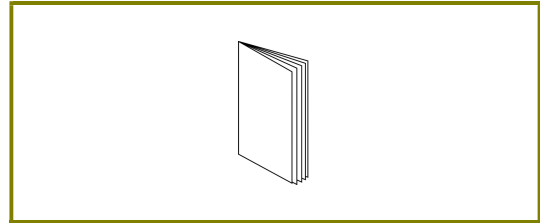

Quick Start Guide

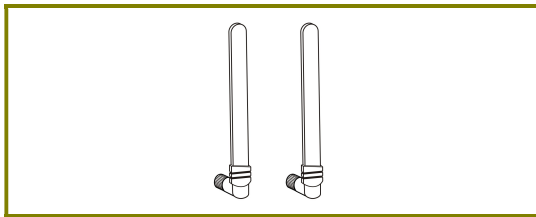

Antenna

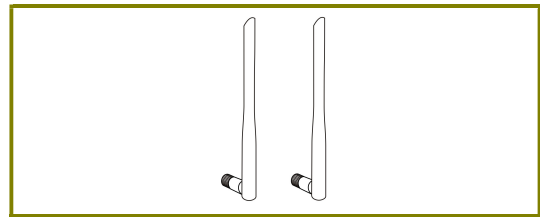

Antenna (for ax model)

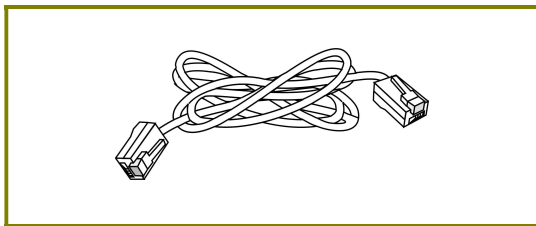

RJ-45 Cat-5 Ethernet Cable

The type of the power adapter depends on the country that the router will be installed. * The maximum power consumption is **18 Watts**.

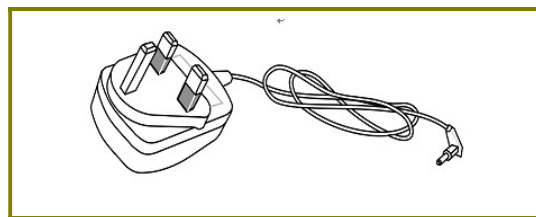

UK-type Power Adapter

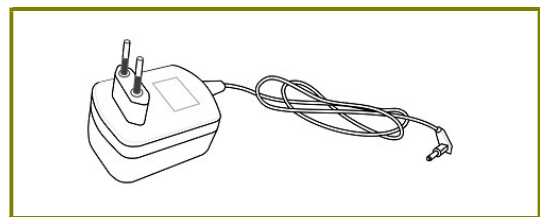

EU-type Power Adapter

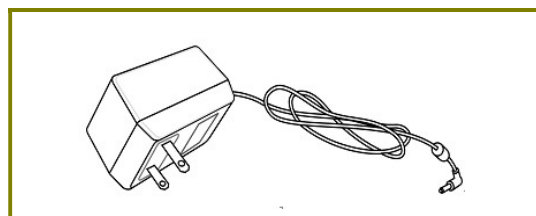

USA/Taiwan-type Power Adapter

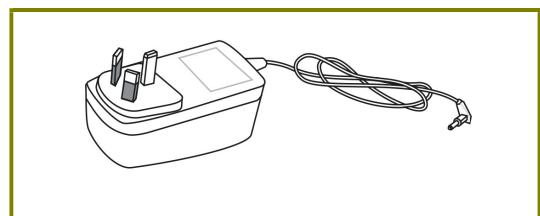

AU/NZ-type Power Adapter



Note

Remove the protective film from the router before use to ensure ventilation.

2. Panel Explanation

2.1 Vigor C410

LED

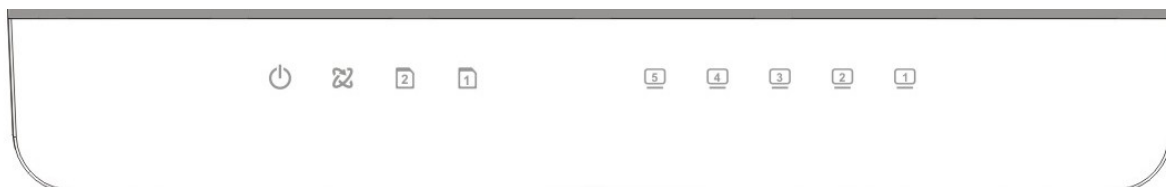

LED	Status	Explanation
	Blinking	The router is powered on and running normally.
	Off	The router is powered off.
	On	Internet connection is ready.
	Blinking	The data is transmitting.
	Off	Internet connection is not ready.
	On	SIM card is inserted into the slot and detected by Vigor device.
	Blinking	No SIM card in detected.
	On	The LAN port is connected.
	Blinking	The data is transmitting.
	Off	The LAN port is disconnected.

Connectors

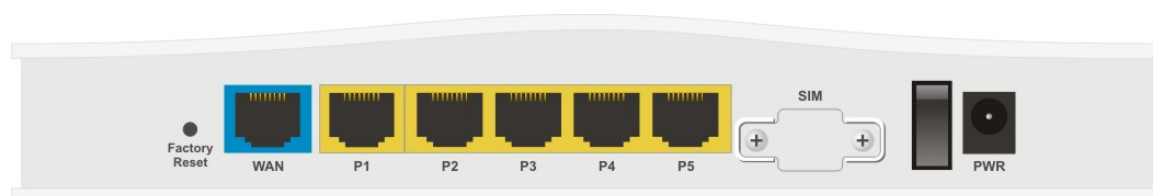

Interface	Description
Factory Reset	Restore the default settings. Usage: Turn on the router (ACT LED is blinking). Press the hole and keep for more than 5 seconds. When you see the ACT LED begins to blink rapidly than usual, release the button. Then the router will restart with the factory default configuration.
WAN	Connector for remote networked devices (by Ethernet cable).
P1~P5	Connectors for local networked devices.
SIM	Slots for installing SIM card(s).
ON/OFF	Power switch.
PWR	Connector for a power adapter.

2.2 Vigor C510

LED



LED	Status	Explanation
	Blinking	The router is powered on and running normally.
	Off	The router is powered off.
	On	Internet connection is ready.
	Blinking	The data is transmitting.
	Off	Internet connection is not ready.
	On	SIM card is inserted into the slot and detected by Vigor device.
	Blinking	No SIM card in detected.
	On	The LAN port is connected.
	Blinking	The data is transmitting.
	Off	The LAN port is disconnected.

Connectors

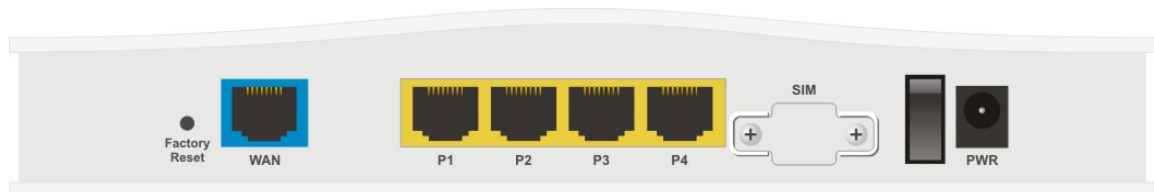



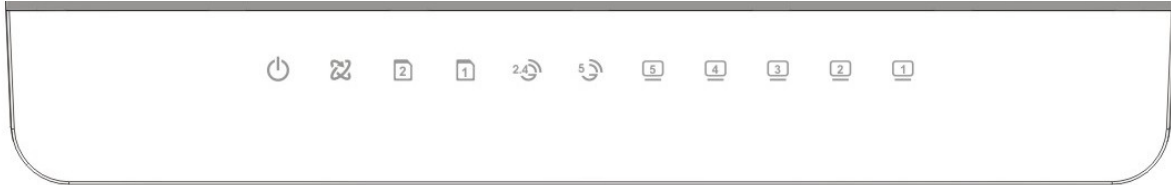

Interface	Description
Factory Reset	Restore the default settings. Usage: Turn on the router (ACT LED is blinking). Press the hole and keep for more than 5 seconds. When you see the ACT LED begins to blink rapidly than usual, release the button. Then the router will restart with the factory default configuration.
WAN	Connector for remote networked devices (by Ethernet cable).
P1-P4	Connectors for local networked devices.
SIM	Slots for installing SIM card(s).
ON/OFF	Power switch.
PWR	Connector for a power adapter.

2.3 Vigor C410ax

LED



LED	Status	Explanation
	Blinking	The router is powered on and running normally.
	Blinking (quickly)	When both ACT and WLAN LEDs blink quickly, it means the WPS function is enabled and active. The system is waiting for a wireless station of connection.
	Off	The router is powered off.
	On	Internet connection is ready.
	Blinking	The data is transmitting.
	Off	Internet connection is not ready.
	On	SIM card is inserted into the slot and detected by Vigor device.
	Blinking	No SIM card in detected.
	On	Wireless access point is ready.
	Blinking	Ethernet packets are transmitting over wireless LAN.
	Blinking (quickly)	When both ACT and WLAN LEDs blink quickly, it means the WPS function is enabled and active. The system is waiting for a wireless station of connection.
	Off	The WLAN function is inactive.
	On	The LAN port is connected.
	Blinking	The data is transmitting.
	Off	The LAN port is disconnected.

Connectors

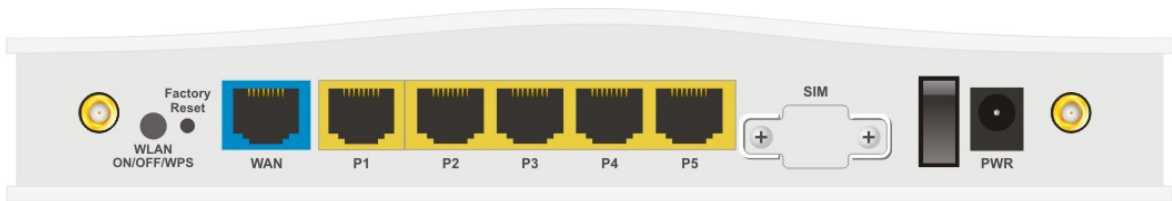





Interface	Description
	Connector for installing WLAN antennas. (For ax model).
WLAN ON/OFF/WPS	<p>WLAN On - Press the button and release it within 2 seconds. When the wireless function is ready, the green LED will be on.</p> <p>WLAN Off - Press the button and release it within 2 seconds to turn off the WLAN function. When the wireless function is not ready, the LED will be off.</p> <p>WPS - When WPS function is enabled by web user interface, press this button for more than 2 seconds to wait for client's device making network connection through WPS.</p>
Factory Reset	<p>Restore the default settings.</p> <p>Usage: Turn on the router (ACT LED is blinking). Press the hole and keep for more than 5 seconds. When you see the ACT LED begins to blink rapidly than usual, release the button. Then the router will restart with the factory default configuration.</p>
WAN	Connector for remote networked devices (by Ethernet cable).
P1~P5	Connectors for local networked devices.
SIM	Slots for installing SIM card(s).
ON/OFF	Power switch.
PWR	Connector for a power adapter.

2.4 Vigor C510ax

LED



LED	Status	Explanation
	Blinking	The router is powered on and running normally.
	Blinking (quickly)	When both ACT and WLAN LEDs blink quickly, it means the WPS function is enabled and active. The system is waiting for a wireless station of connection.
	Off	The router is powered off.
	On	Internet connection is ready.
	Blinking	The data is transmitting.
	Off	Internet connection is not ready.
	On	SIM card is inserted into the slot and detected by Vigor device.
	Blinking	No SIM card in detected.
	On	Wireless access point is ready.
	Blinking	Ethernet packets are transmitting over wireless LAN.
	Blinking (quickly)	When both ACT and WLAN LEDs blink quickly, it means the WPS function is enabled and active. The system is waiting for a wireless station of connection.
	Off	The WLAN function is inactive.
	On	The LAN port is connected.
	Blinking	The data is transmitting.
	Off	The LAN port is disconnected.

Connectors

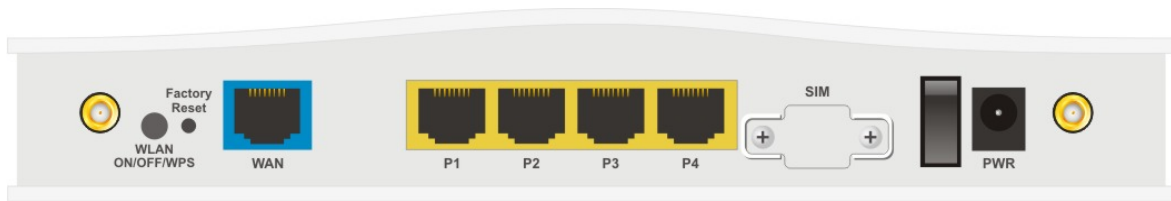

Interface	Description
	Connector for installing WLAN antennas. (For ax model).
WLAN ON/OFF/WPS	<p>WLAN On - Press the button and release it within 2 seconds. When the wireless function is ready, the green LED will be on.</p> <p>WLAN Off - Press the button and release it within 2 seconds to turn off the WLAN function. When the wireless function is not ready, the LED will be off.</p> <p>WPS - When WPS function is enabled by web user interface, press this button for more than 2 seconds to wait for client's device making network connection through WPS.</p>
Factory Reset	<p>Restore the default settings.</p> <p>Usage: Turn on the router (ACT LED is blinking). Press the hole and keep for more than 5 seconds. When you see the ACT LED begins to blink rapidly than usual, release the button. Then the router will restart with the factory default configuration.</p>
WAN	Connector for remote networked devices (by Ethernet cable).
P1~P4	Connectors for local networked devices.
SIM	Slots for installing SIM card(s).
ON/OFF	Power switch.
PWR	Connector for a power adapter.

3. Hardware Installation

This section will guide you to install the router through hardware connection and configure the router's settings through web browser.

3.1 Network Connection

Before starting to configure the router, you have to connect your devices correctly. Here we take Vigor C410 as an example.

1. Connect the cable Modem/DSL Modem/Media Converter to any WAN port of router with Ethernet cable (RJ-45).
2. Connect one end of an Ethernet cable (RJ-45) to one of the LAN ports of the router and the other end of the cable (RJ-45) into the Ethernet port on your computer.
3. Connect one end of the power cord to the power port of this device. Connect the other end to the wall outlet of electricity.
4. Power on the router. Then, check the **ACT** and **WAN**, **LAN** LEDs on the front panel to assure network connection.

(For the detailed information of LED status, please refer to section 2. Panel Explanation)

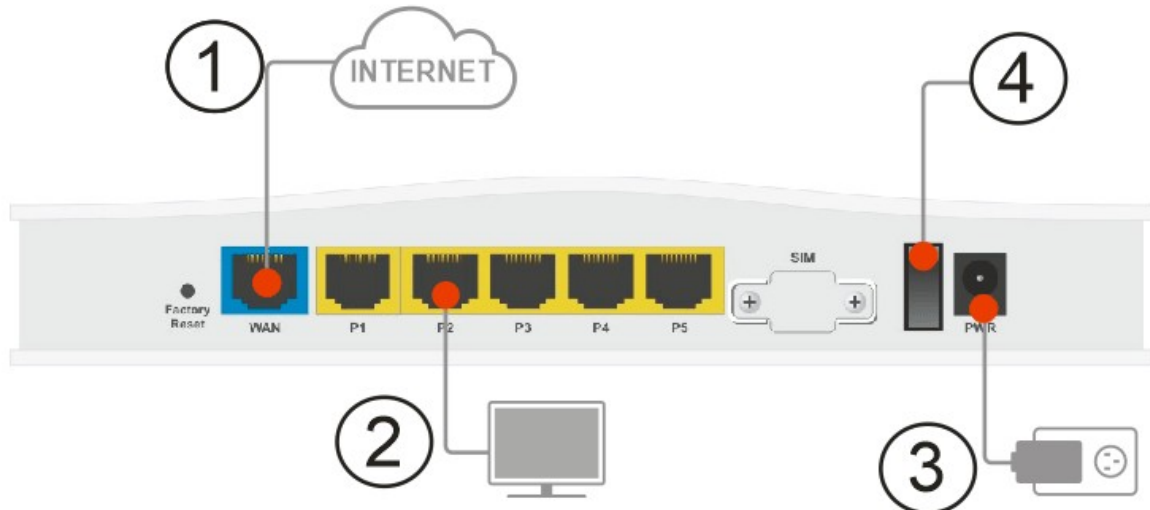

3.2 Wall-Mounted Installation

Vigor router series has keyhole type mounting slots on the underside.

1. Drill two holes on the wall. The distance between the holes shall be 168mm.
2. Fit screws into the wall using the appropriate type of wall plug.
3. With the screws installed, the router can be slotted into place.

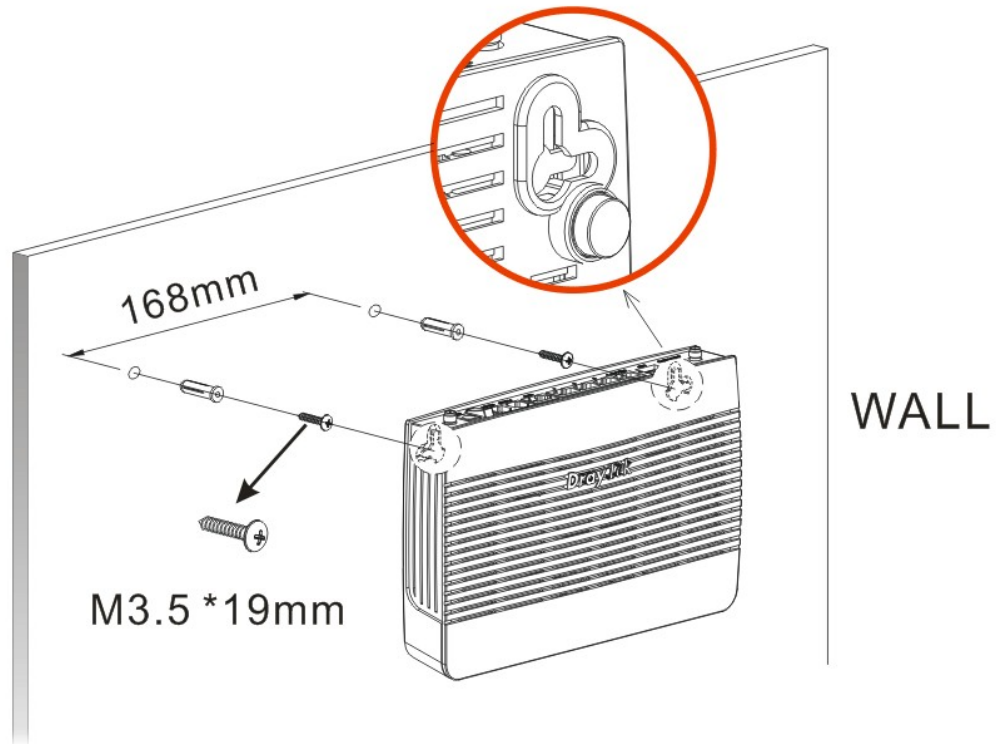

Note

The recommended drill diameter shall be 6.5mm (1/4").

4. When you finished about procedure, the router has been mounted on the wall firmly.

3.3 Antenna Installation

Antenna must be installed on Vigor router correctly to obtain the transmission signal.

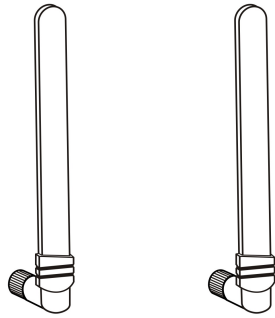

For model with SIM installed

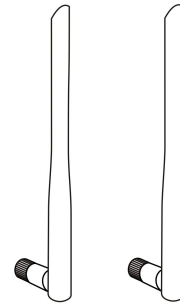

For ax models

There are two types of antennas provided for Vigor C410ax / C510ax, which must be installed in different locations carefully and correctly. Wrong installation might cause bad signal of wireless connection. Therefore, pay attention to the installation of antennas by referring to the following illustration.

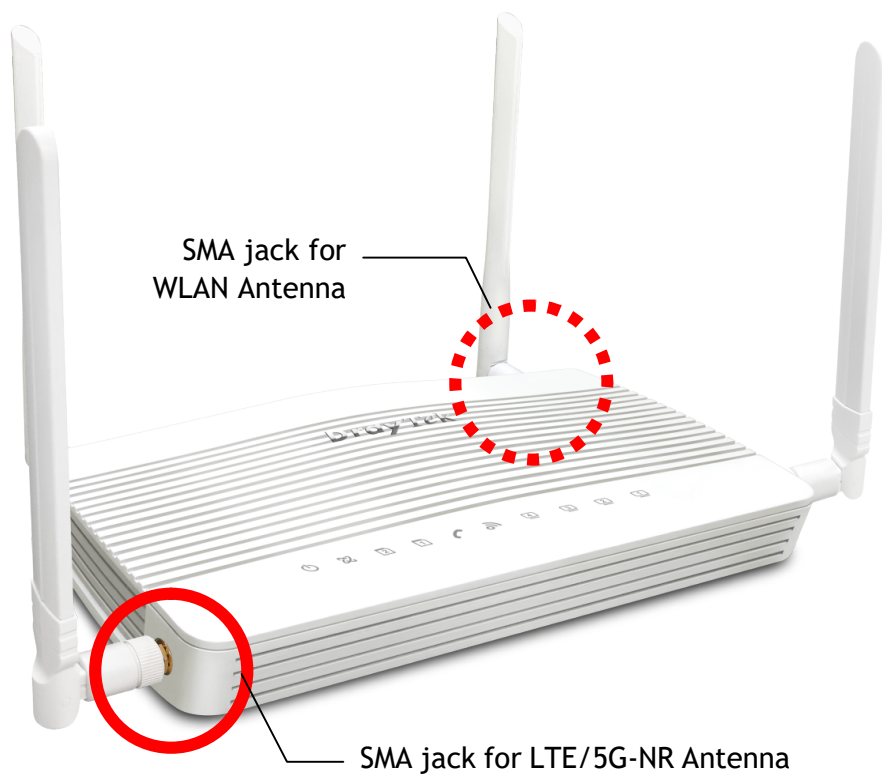

Note: The antennas for Vigor C410 must be installed on both sides of the device. If only one antenna will be used, please install on the left side of Vigor router.

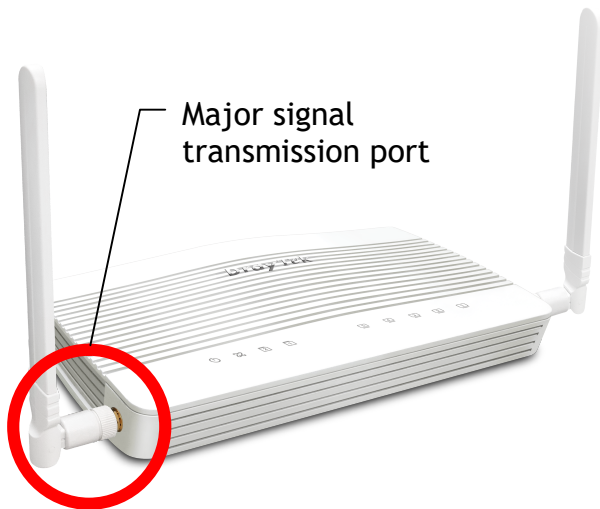

For installing the SIM card into the card slot,

- (1) While installing the SIM card into the card slot, note that the back plate of the SIM card slot must be removed first.
- (2) Assemble the SIM1 and SIM2 with the card cassette. Later insert the cassette into the SIM card slot.

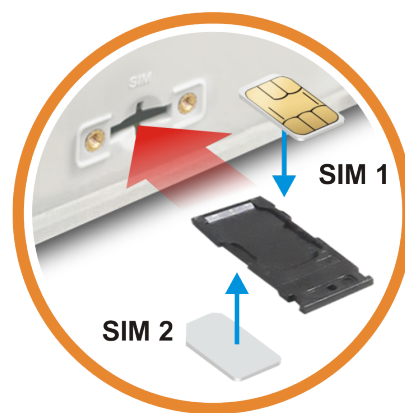

4. Software Configuration

By default, you can access the Internet if you finish the hardware installation. However, you might need to access the web user interface of the Vigor router for some reason; for this, follow the steps listed below.

1. Make sure your PC connects to the router correctly.
2. Open a web browser on your PC and type **https://192.168.1.1**. A pop-up window will open to ask for username and password. Please enter “admin/admin” as the Username/Password and click **Login**.

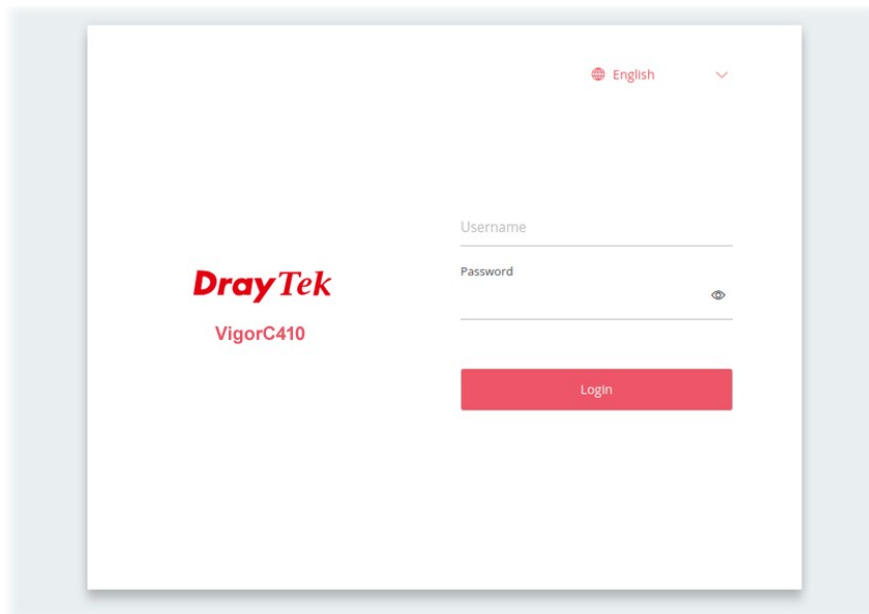

Note

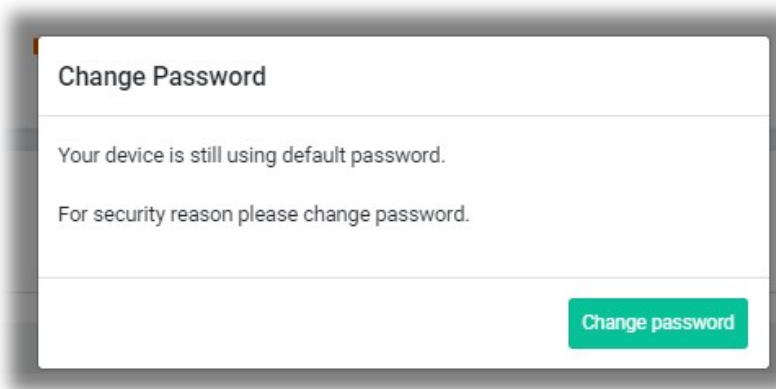

You may either simply set up your computer to get IP dynamically from the router or set up the IP address of the computer to be the same subnet as the **default IP address of Vigor router 192.168.1.1**.

3. Next, the page will appear to guide you change the login password.



- You **MUST** change the login password before accessing the web user interface. Please set a new password for network security.

admin / Set Password

Account	admin
Current Password 
New Password 
Confirm New Password 

- ✓ At least 8 characters
- ✓ Uppercase characters
- ✓ Lowercase characters
- ✓ Numbers or Special characters ~!@#%&*()_ = / ? [] { } < > \

- Now, the Main Screen will pop up.

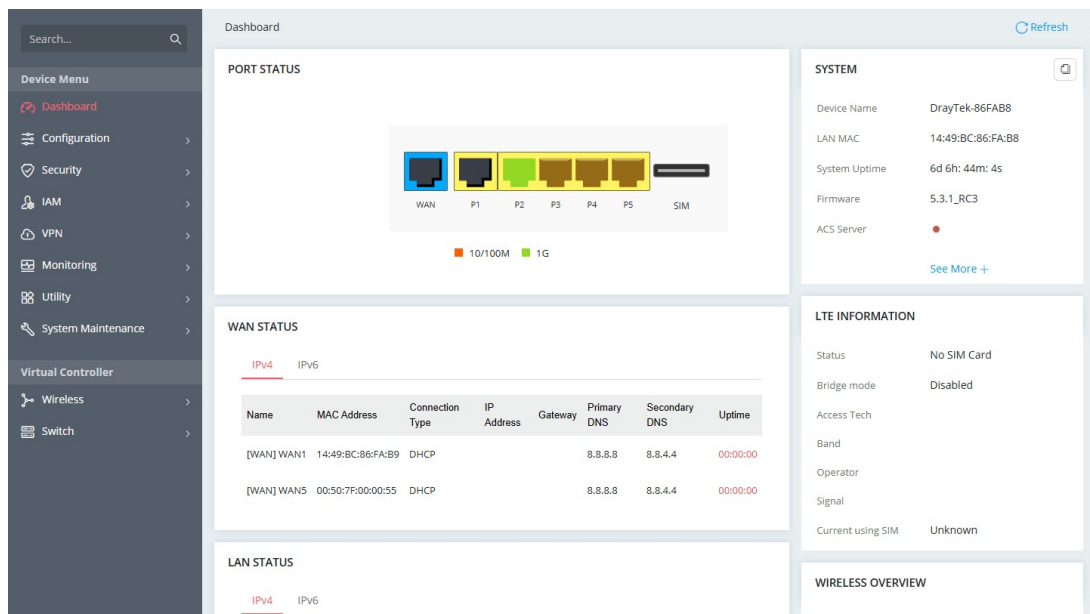

Dashboard

PORT STATUS

WAN P1 P2 P3 P4 P5 SIM

10/100M 1G

WAN STATUS

Name	MAC Address	Connection Type	IP Address	Gateway	Primary DNS	Secondary DNS	Uptime
[WAN] WAN1	14:49:BC:86:FA:B9	DHCP			8.8.8.8	8.8.4.4	00:00:00
[WAN] WAN5	00:50:7F:00:00:55	DHCP			8.8.8.8	8.8.4.4	00:00:00

LAN STATUS

SYSTEM

Device Name: DrayTek-86FAB8
LAN MAC: 14:49:BC:86:FA:B8
System Uptime: 6d 6h: 44m: 4s
Firmware: 5.3.1_RC3
ACS Server: 

LTE INFORMATION

Status: No SIM Card
Bridge mode: Disabled
Access Tech:
Band:
Operator:
Signal:
Current using SIM: Unknown

WIRELESS OVERVIEW



Note

The home page will change slightly in accordance with the router you have.

5. Customer Service

If the router cannot work correctly after trying many efforts, please contact your dealer/DrayTek for further help right away. For any questions, please feel free to send e-mail to support@draytek.com.

Be a Registered Owner

Web registration is preferred. You can register your Vigor router via <https://myvigor.draytek.com>.

Firmware & Tools Updates

Due to the continuous evolution of DrayTek technology, all routers will be regularly upgraded. Please consult the DrayTek web site for more information on newest firmware, tools and documents.

<https://www.draytek.com>